

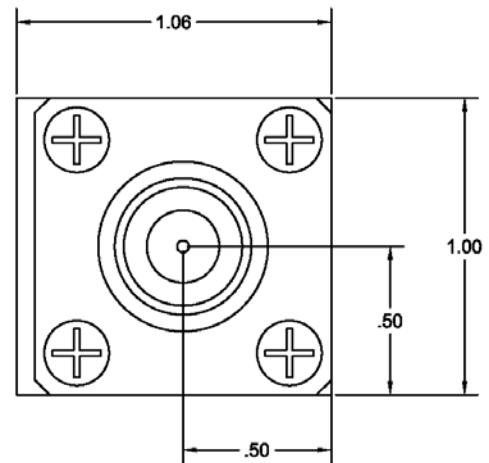

# FHC-21A

# UHF DC BLOCK

Features high RF power handling, Optimized for 30 to 512 MHz

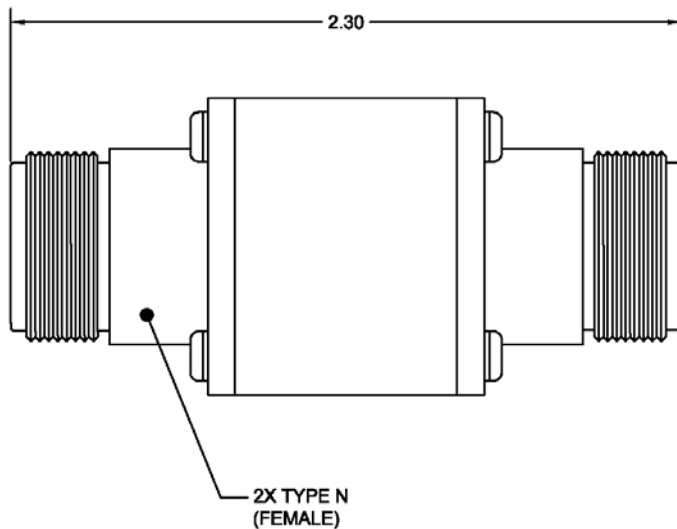

## ELECTRICAL SPECIFICATIONS

Frequency Range	30 - 512 MHz
Insertion Loss	0.1 dB max.
VSWR (Reference 50 Ohms)	1.2:1 max.
RF Power Input, CW	250 W max.
Blocking Voltage	200 WVDC

## GENERAL CHARACTERISTICS

Weight	3.5 oz.
Size	1.00" x 1.06" x 2.30"
Connectors	Type N (female)

REV: 5/29/15