

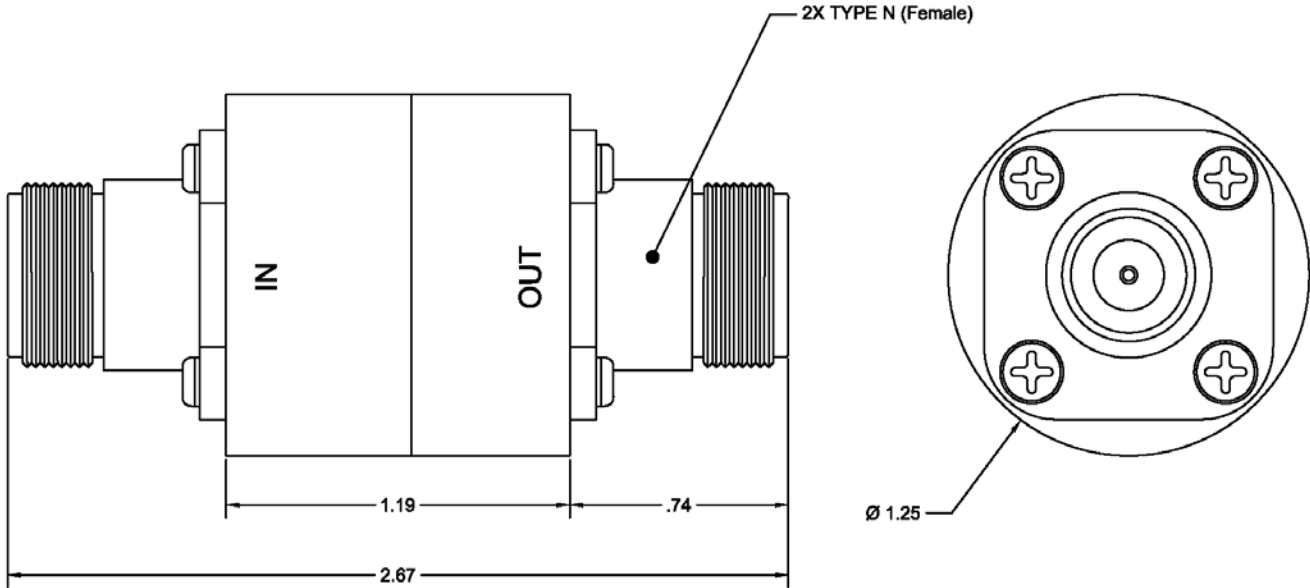

# LM-15-75

# EMP LIMITER



## ELECTRICAL SPECIFICATIONS

Insertion Loss	
0-512 MHz	0.15 dB max.
512-900 MHz	0.5 dB max.
VSWR	
0-512 MHz	1.25:1 max.
512-750 MHz	1.5:1 max.
Impedance	50Ω nom.
EMP Protection Level*	75 V nom.

\* Values from 7 to 360 V available, indicated by Suffix "-XX"

## GENERAL CHARACTERISTICS

Size, overall length	1.25" dia. x 2.67"
Weight	6 oz.
Connectors	TYPE N (Female)

REV: 10/17/16