



LM-15-100

EMP LIMITER



DESCRIPTION

The model LM-15-100 limiter provides EMP protection for many kinds of communications equipment. The clamp protection level is nominally 100V, indicated by - 100. Other levels may be specified from 7 to 360 volts. Contact MPI for specific voltage requirements.

RF power handling is contingent on the voltage protection level.

FEATURES

Compact Coaxial EMP Limiter

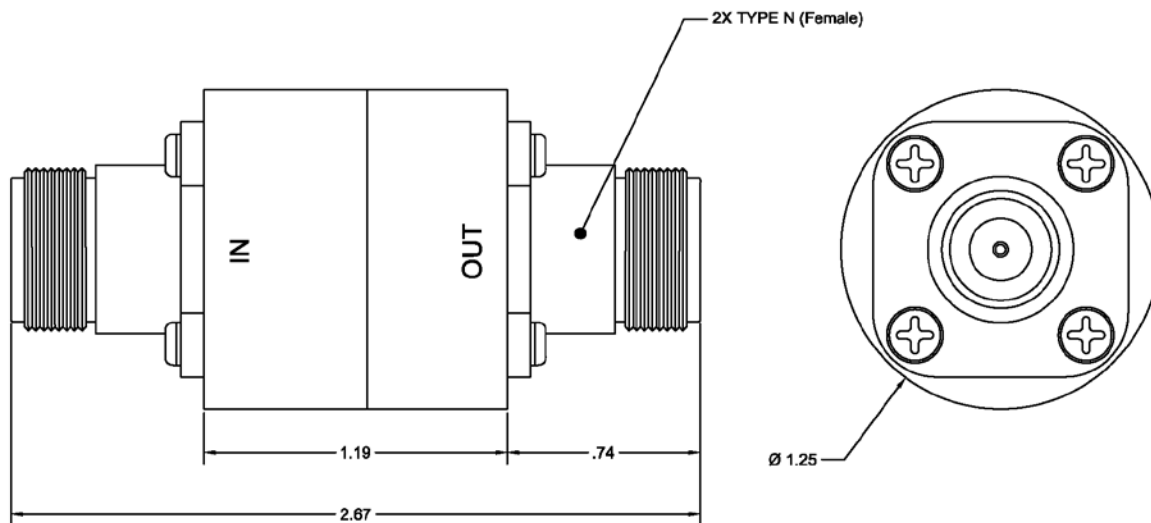

ELECTRICAL SPECIFICATIONS

Insertion Loss	
0-512 MHz	0.15 dB max.
512-750 MHz	0.25 dB max.
750-850 MHz	0.40 dB max.
Impedance	50 Ω nom.
VSWR	
0-512 MHz	1.25:1 max.
512-850 MHz	1.5:1 max.
EMP Protection Level*	100 V nom.

* values from 7 to 360 V available, indicated by Suffix"-XX"

GENERAL CHARACTERISTICS

Size, overall length	Ø1.25" x 2.67"
Weight	7oz. nom.
Connectors	Type N (Female)

REV: 7/25/18